



## Characteristics



- Self-supporting casing construction made of galvanized steel plate, finished in structural epoxy-polyester painting white colour RAL9016 as standard. Other colours or stainless steel are available on request.
- Micro-perforated inlet grille with filter functions and easy service. It does not need prefilter.
- Anodized aluminium outlet vanes, airfoil shaped, adjustable from 0 to 15° each side.
- Double-inlet centrifugal fans driven by an external rotor motor and low noise level. 5-speed selector. "EC" models assembled with very low consumption efficiency fans.
- "P" type with water heated coil. "E" type with electrical shielded elements, three stages with integrated regulation. "A" type without heating, air only. Optional expansion DX coil.
- Includes Plug&Play control with 7m RJ45 cable and infrared remote control. Optional: Clever control (programmable, automatic, intelligent, energy saving, Modbus RTU for BMS...).

## Specifications

### AIR ONLY

Model	Airflow m³/h	Power Fans 230V-50Hz kW	Current Fans 230V-50Hz A	Noise Level (5 m) dB(A)	Weight kg
M 1000 A	1800	0,212	0,94	55	31
M 1500 A	2700	0,318	1,41	56	46
M 2000 A	3600	0,424	1,88	57	58
M 2500 A	4500	0,530	2,35	58	72
M 3000 A	5400	0,636	2,82	59	86
ECM 1000 A	1840	0,132	1,14	56	31
ECM 1500 A	2760	0,198	1,71	57	46
ECM 2000 A	3680	0,264	2,28	58	58
ECM 2500 A	4600	0,330	2,85	59	72
ECM 3000 A	5520	0,396	3,42	60	86
G 1000 A	2400	0,642	2,85	57	43
G 1500 A	3200	0,856	3,80	58	51
G 2000 A	4800	1,284	5,70	59	80
G 2500 A	5600	1,498	6,65	60	84
G 3000 A	6400	1,712	7,60	61	95
ECG 1000 A	2700	0,225	1,95	61	43
ECG 1500 A	3600	0,300	2,60	62	51
ECG 2000 A	5400	0,450	3,90	63	80
ECG 2500 A	6300	0,525	4,55	64	84
ECG 3000 A	7200	0,600	5,20	65	95

### ELECTRICAL HEATED

Model	Airflow m³/h	Electrical Heating Capacity 400Vx3-50Hz kW	Power Fans 230V-50Hz kW	Current Fans 230V-50Hz A	Noise Level (5 m) dB(A)	Weight kg
M 1000 E	1800	3/6/9	0,212	0,94	55	37
M 1500 E	2700	4/8/12	0,318	1,41	56	57
M 2000 E	3600	6/12/18	0,424	1,88	57	75
M 2500 E	4500	6/12/18	0,530	2,35	58	94
M 3000 E	5400	8/16/24	0,636	2,82	59	112
ECM 1000 E	1840	3/6/9	0,132	1,14	56	37
ECM 1500 E	2760	4/8/12	0,198	1,71	57	57
ECM 2000 E	3680	6/12/18	0,264	2,28	58	75
ECM 2500 E	4600	6/12/18	0,330	2,85	59	94
ECM 3000 E	5520	8/16/24	0,396	3,42	60	112
G 1000 E	2400	5/10/15	0,642	2,85	57	52
G 1500 E	3200	7,5/15/22,5	0,856	3,80	58	63
G 2000 E	4800	10/20/30	1,284	5,70	59	100
G 2500 E	5600	10/20/30	1,498	6,65	60	106
G 3000 E	6400	10/20/30	1,712	7,60	61	120
ECG 1000 E	2700	5/10/15	0,225	1,95	61	52
ECG 1500 E	3600	7,5/15/22,5	0,300	2,60	62	63
ECG 2000 E	5400	10/20/30	0,450	3,90	63	100
ECG 2500 E	6300	10/20/30	0,525	4,55	64	106
ECG 3000 E	7200	10/20/30	0,600	5,20	65	120

### WATER HEATED

Model	Airflow m³/h	P86		P64		P54		Power Fans 230V-50Hz kW	Current Fans 230V-50Hz A	Noise Level (5 m) dB(A)	Weight kg
		Heating capacity 80/60°C kW	Water Drop Pressure 80/60°C Pa	Heating Capacity 60/40°C kW	Water Drop Pressure 60/40°C Pa	Heating Capacity 50/40°C kW	Water Drop Pressure 50/40°C Pa				
M 1000 P	1660	9,17	880	8,56	4370	8,52	1220	0,428	1,90	56	35
M 1500 P	2490	14,26	760	13,69	6460	14,34	4480	0,642	2,85	57	53
M 2000 P	3320	20,65	1930	18,26	4790	18,65	2060	0,856	3,80	58	69
M 2500 P	4150	26,92	3810	22,12	3850	24,32	4040	1,070	4,75	59	86
M 3000 P	4980	33,24	6590	28,37	6760	29,77	5660	1,280	5,70	60	103
ECM 1000 P	1720	9,38	920	8,77	4560	8,74	1280	0,132	1,14	56	35
ECM 1500 P	2580	14,58	790	14,02	6730	14,71	4690	0,198	1,71	57	53
ECM 2000 P	3440	21,12	2010	18,70	4990	19,13	2150	0,264	2,28	58	69
ECM 2500 P	4300	27,53	3960	23,33	4010	24,95	4230	0,330	2,85	59	86
ECM 3000 P	5160	40,00	6860	29,05	7050	30,54	5920	0,396	3,42	60	103
G 1000 P	2250	11,04	1230	10,42	6190	10,56	1790	0,642	2,85	57	50
G 1500 P	3000	16,02	940	15,47	8020	16,37	5670	0,856	3,80	58	59
G 2000 P	4500	24,92	2700	22,29	6810	23,15	3030	1,284	5,70	59	92
G 2500 P	5250	31,16	4930	26,61	5060	28,76	5450	1,498	6,65	60	96
G 3000 P	6000	37,35	8110	32,10	8410	34,03	7180	1,712	7,60	61	109
ECG 1000 P	2550	11,89	1400	11,27	7110	11,50	2090	0,225	1,95	61	50
ECG 1500 P	3400	17,29	1070	16,77	9240	17,86	6620	0,300	2,60	62	59
ECG 2000 P	5100	26,86	3080	24,14	7850	25,24	3530	0,450	3,90	63	92
ECG 2500 P	5950	33,63	5650	28,84	5840	31,38	6360	0,525	4,55	64	96
ECG 3000 P	6800	40,34	9290	34,81	9710	37,16	8400	0,600	5,20	65	109

Water heated: connection pipes P86 and P64 are 2x3/4" female (male if lateral pipes), P54 2x1" male. P86 2 rows coil, P64 3 rows coil, P54 4 rows coil.



Layouts and dimensions

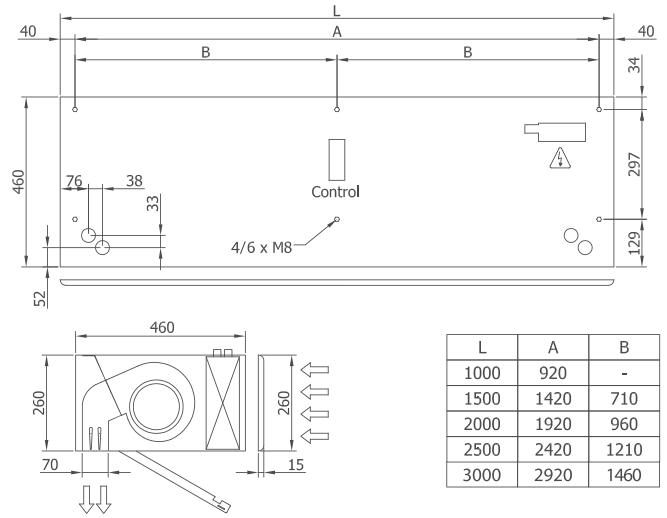

Free hanging mounting

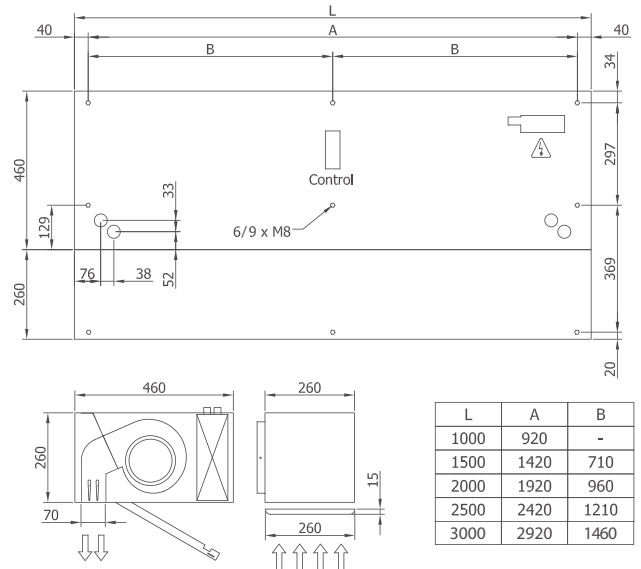

Inside ceiling surface mounting

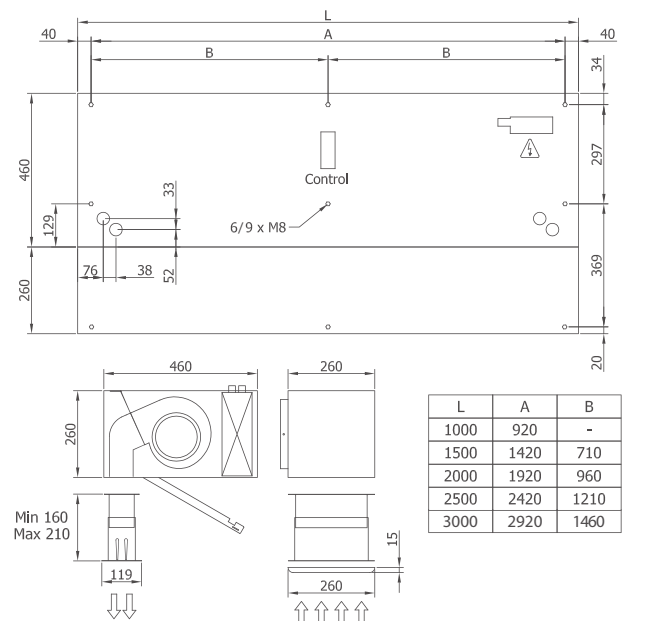

False ceiling invisible mounting